

CORTE 2-2 Escala 1:50

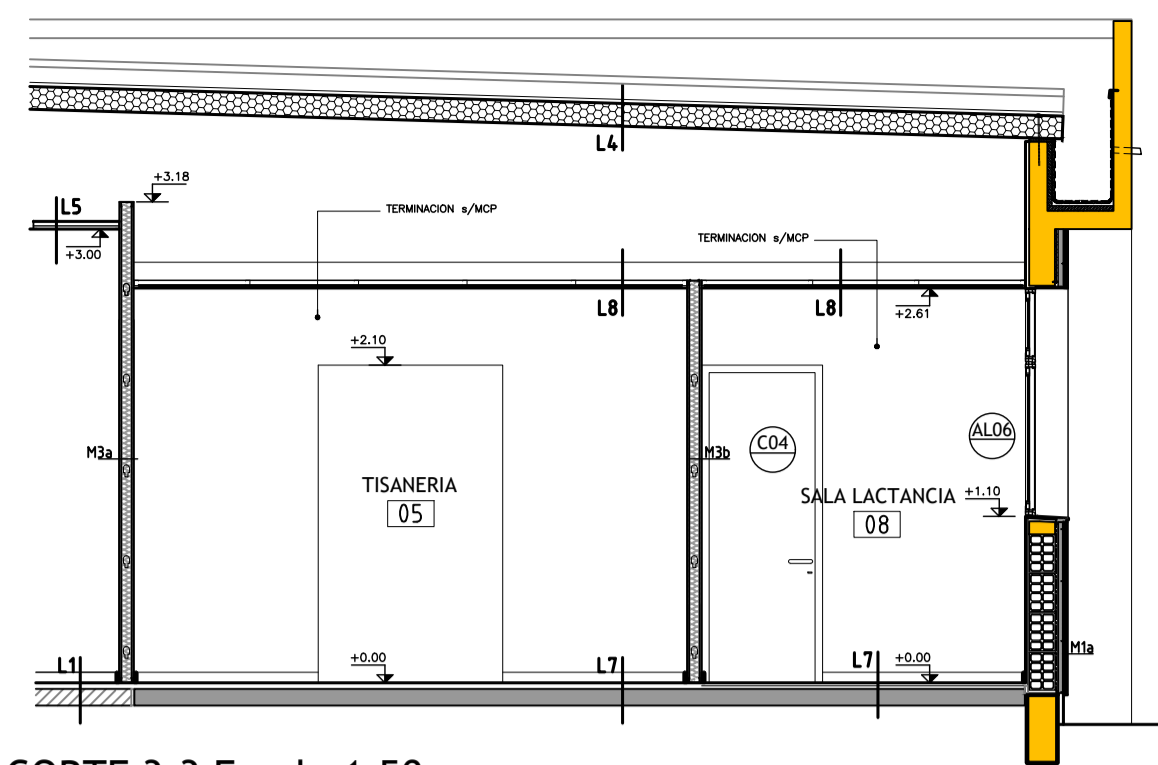

CORTE 3-3 Escala 1:50

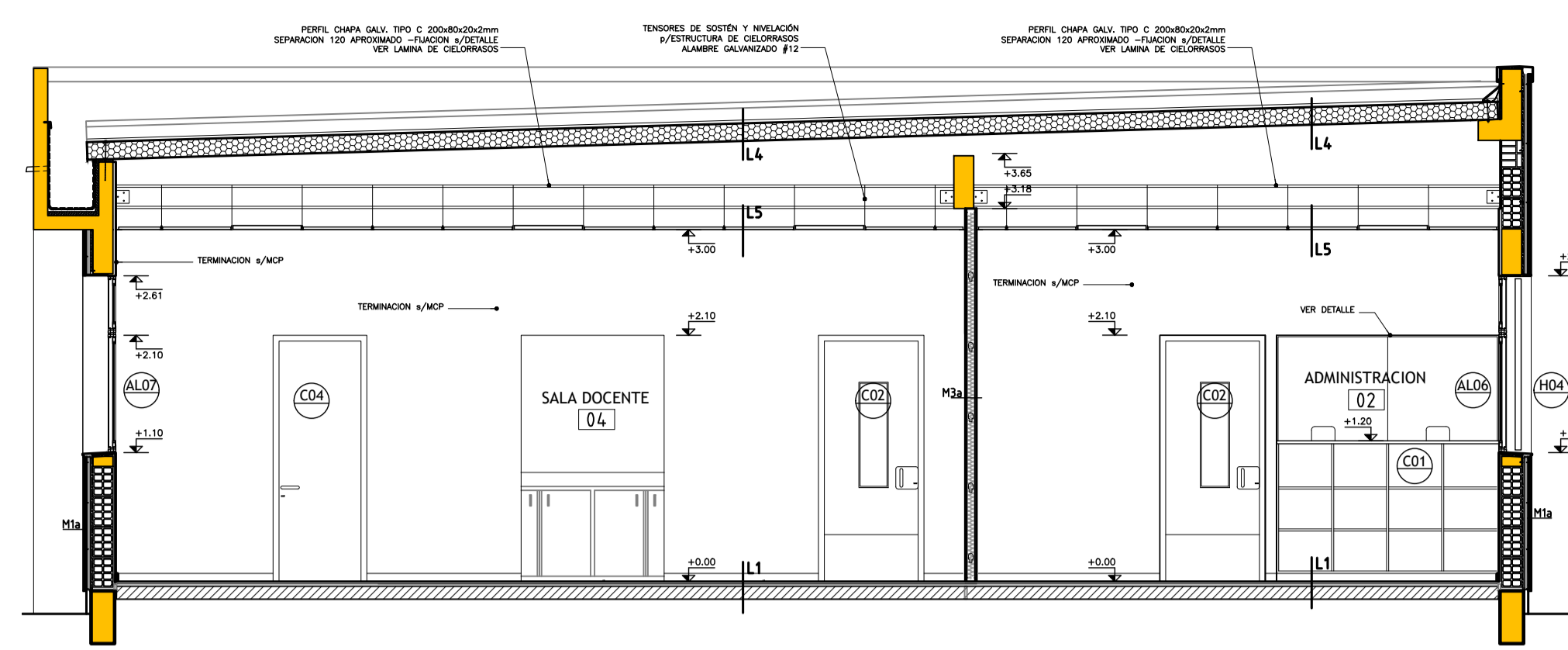

CORTE LONG. POR LOCALES N° 2 y 4 Escala 1:50

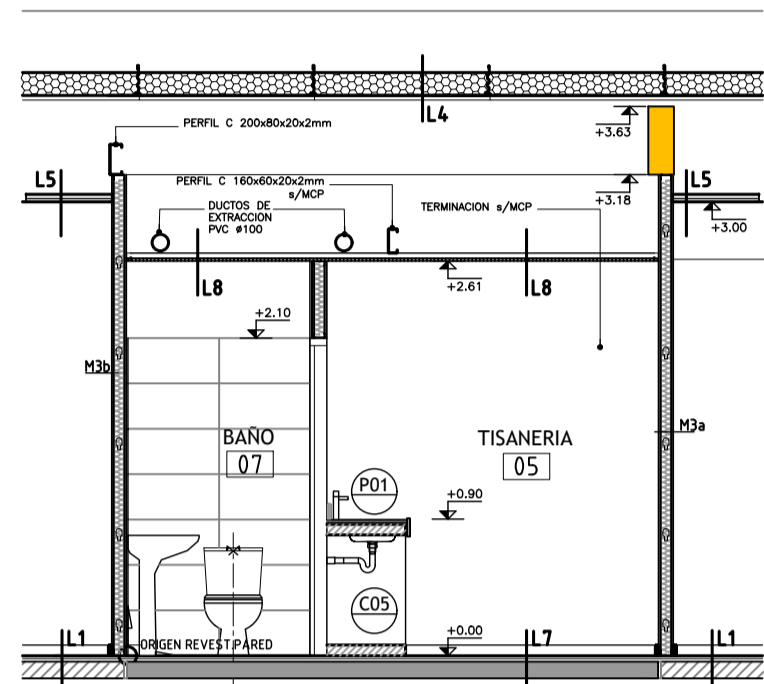

CORTE 1-1 Escala 1:50

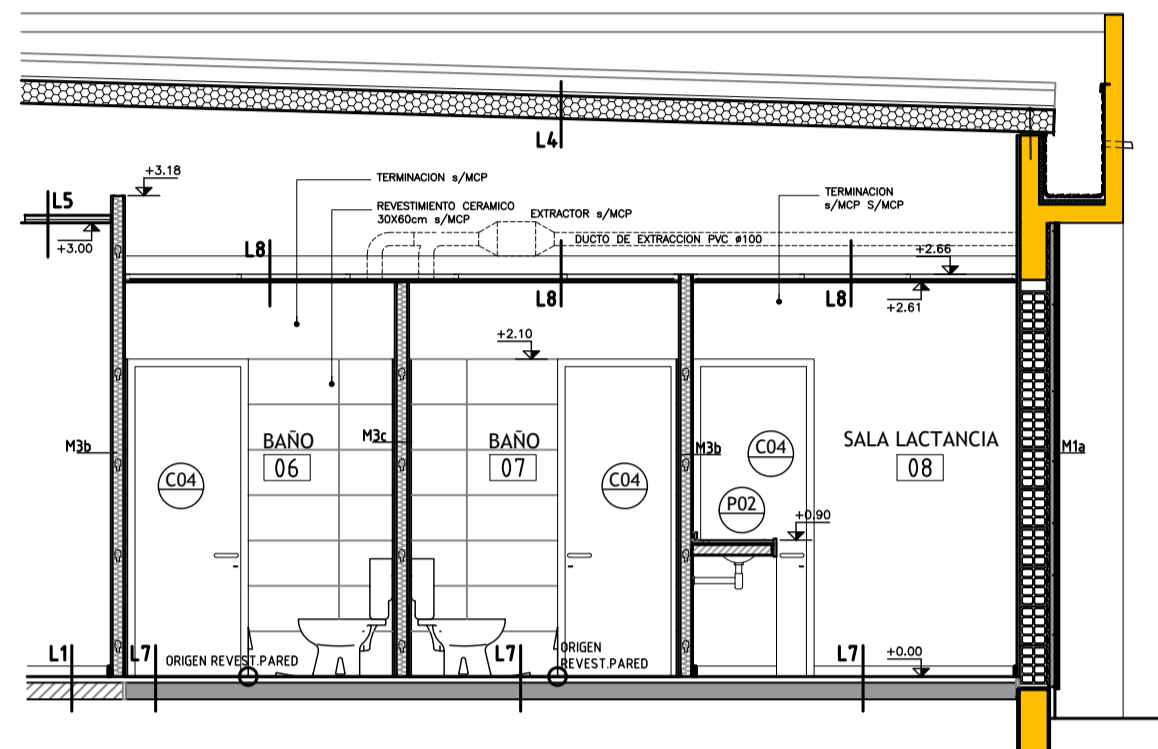

CORTE 4-4 Escala 1:50

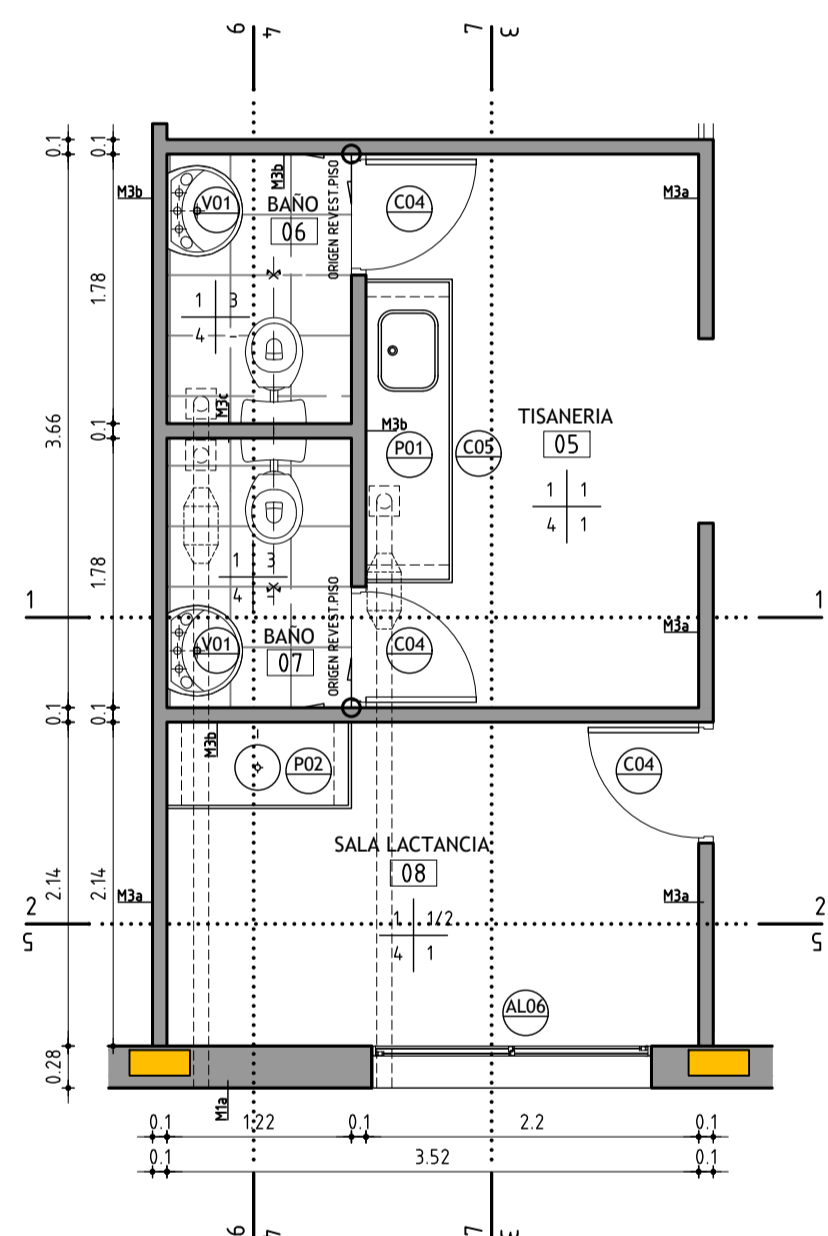

PLANTA Escala 1:50

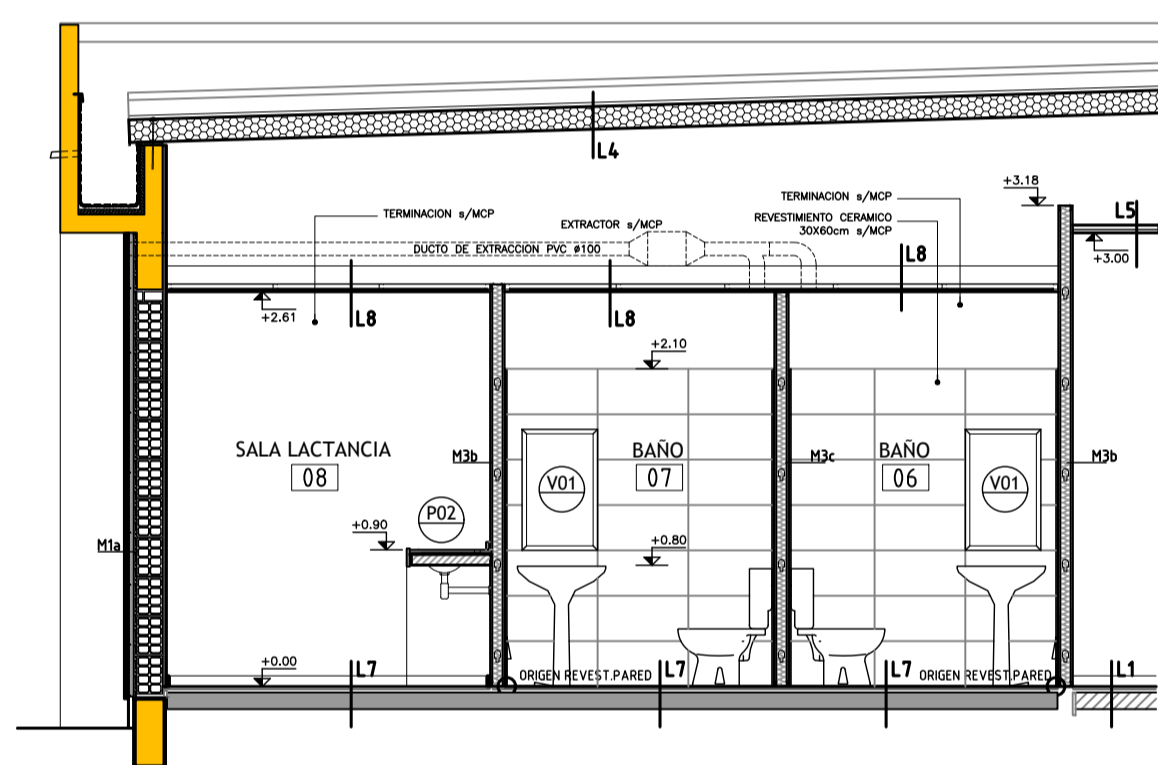

CORTE 6-6 Escala 1:50

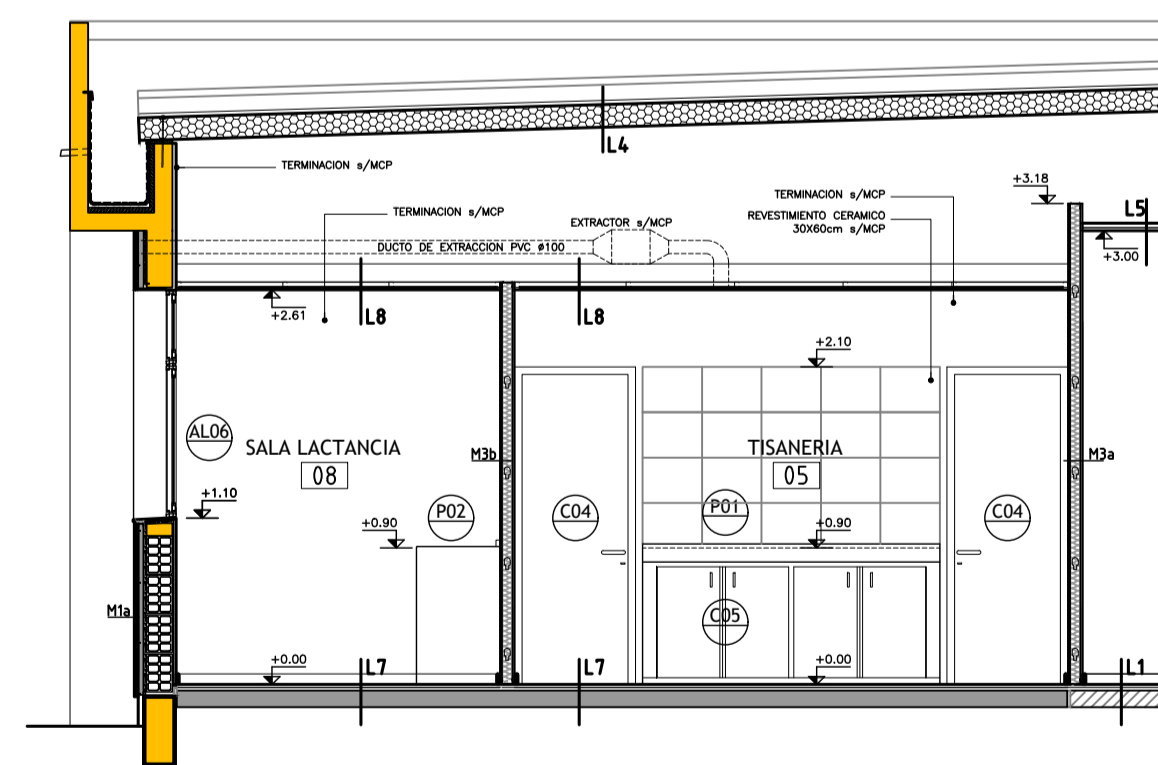

CORTE 7-7 Escala 1:50

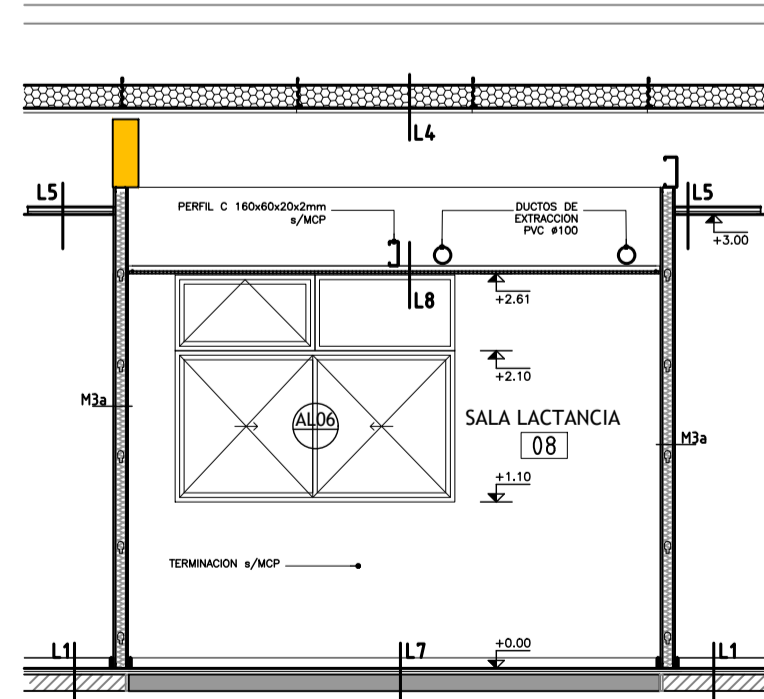

CORTE 5-5 Escala 1:50

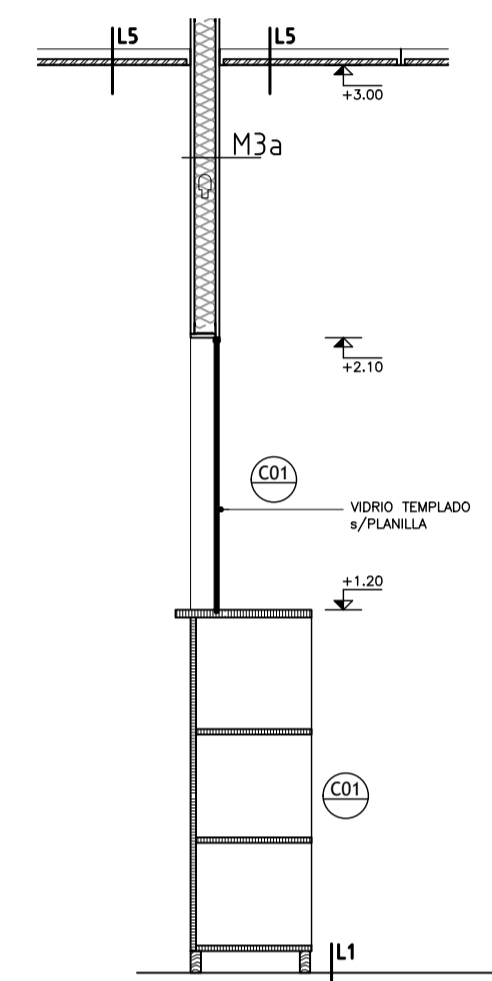

CORTE MOSTRADOR DE ADMINISTRACION Escala 1:25

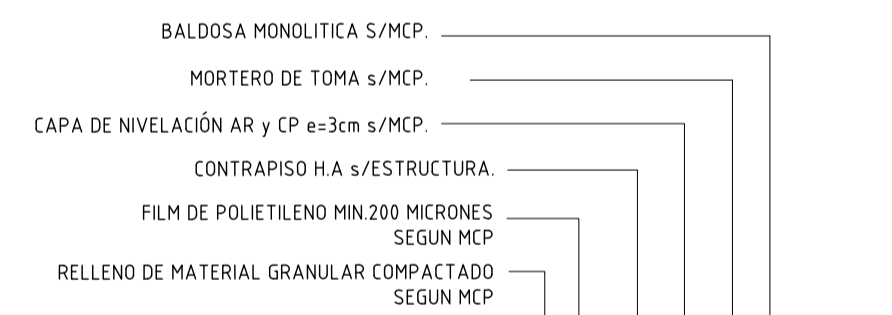

L1 Escala 1:10

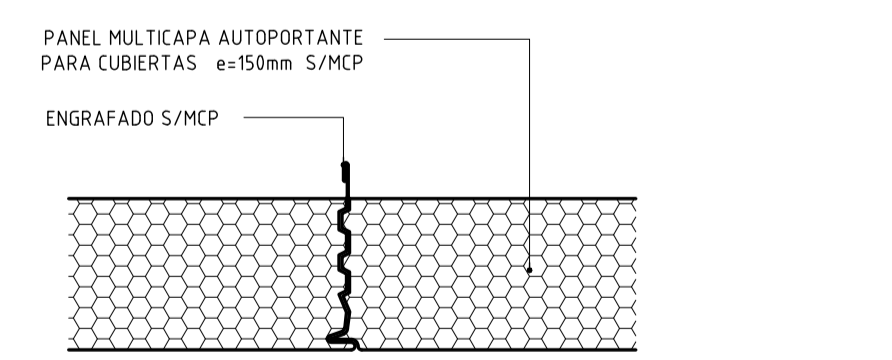

L4 Escala 1:10

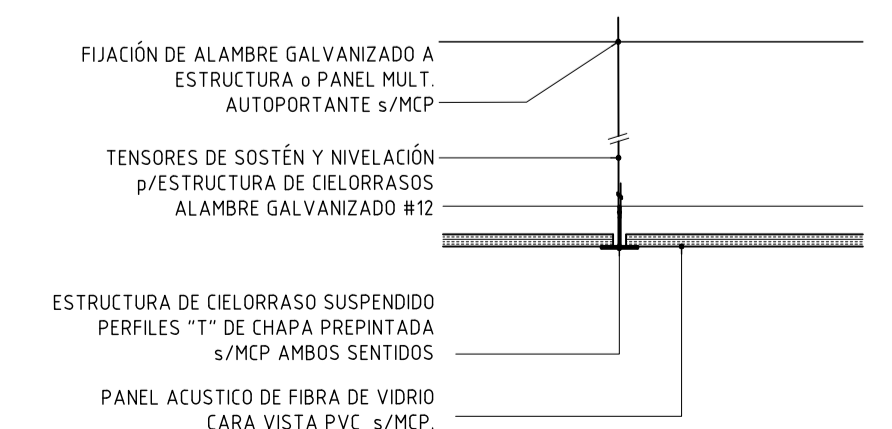

L5 Escala 1:10

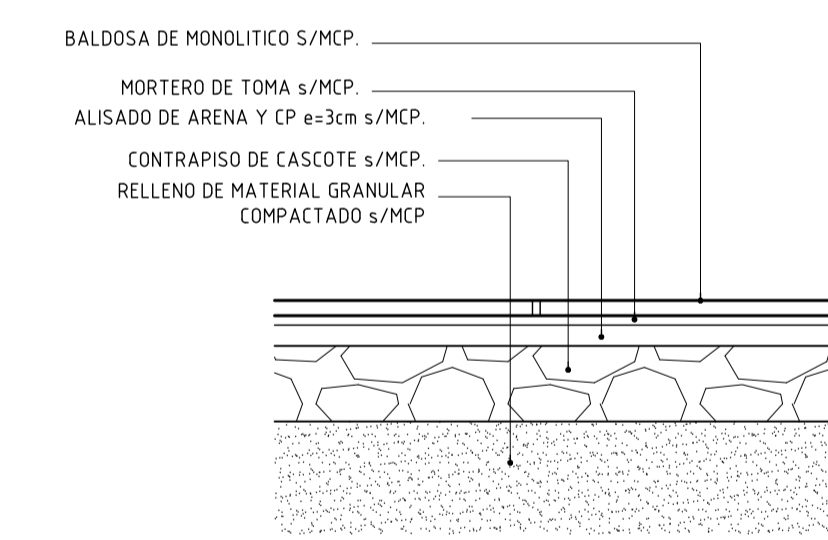

L7 Escala 1:10



L8 Escala 1:10

PLANILLA DE MUROS	
REFERENCIAS es:c: 1:20	11- REVOQUE GUESO BAJO REVESTIMIENTO Y ADHESIVO PREDOSIFICADO
1- TICHULO 17x25x25cm	12- REVOQUE IMPERMEABLE ARENA Y PORTLAND - HIDRÓFUGO
2 - MORTERO DE ASIENTO O TOMA	13- ADHESIVO PREDOSIFICADO
3 - REVOQUE INTERIOR GUESO Y FINO	14- PINTURA S/MCP
4 - AZOTADA c/MORTERO	15- ENDUIDO + PINTURA S/MCP
5 - AISLANTE TÉRMICO/ACÚSTICO e=50mm	16 - CAPA DE MORTERO TIPO SIKATOP SEAL 107 SEGUN MCP
6 - PLACA DE YESO COMÚN e=12.5mm	17- PERFIL MONTANTE 70mm DE CHAPA GALV. S/MCP
7 - PLACA DE YESO VERDE e=12.5mm	18 - TERMINACIÓN A DEFINIR
8 - PLACA CEMENTICIA DOBLE e=12.5mm	
9 - PERIL CHAPA GALV. 190 C. 200x25x25mm	
10 - REVESTIMIENTO CERÁMICO	

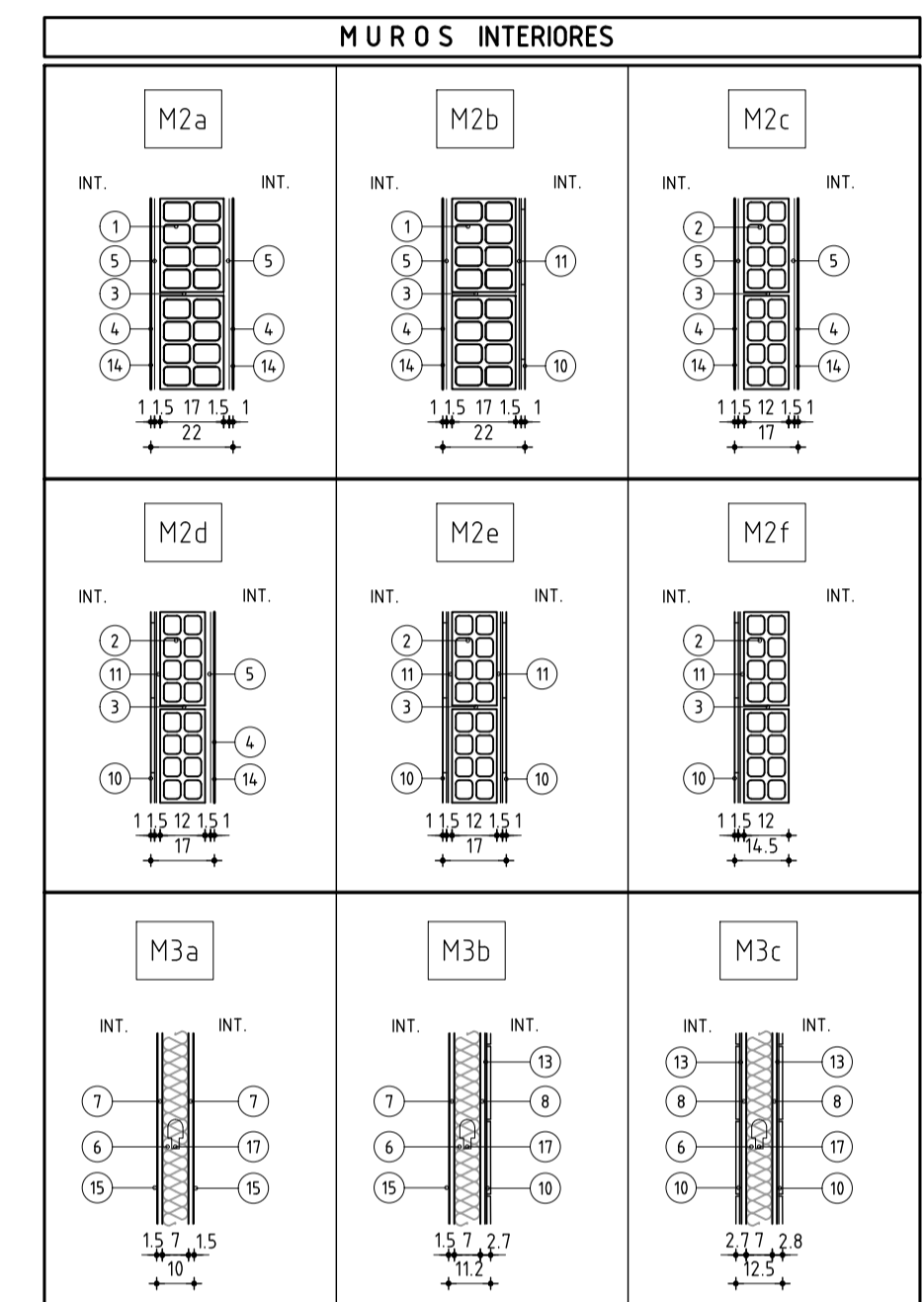
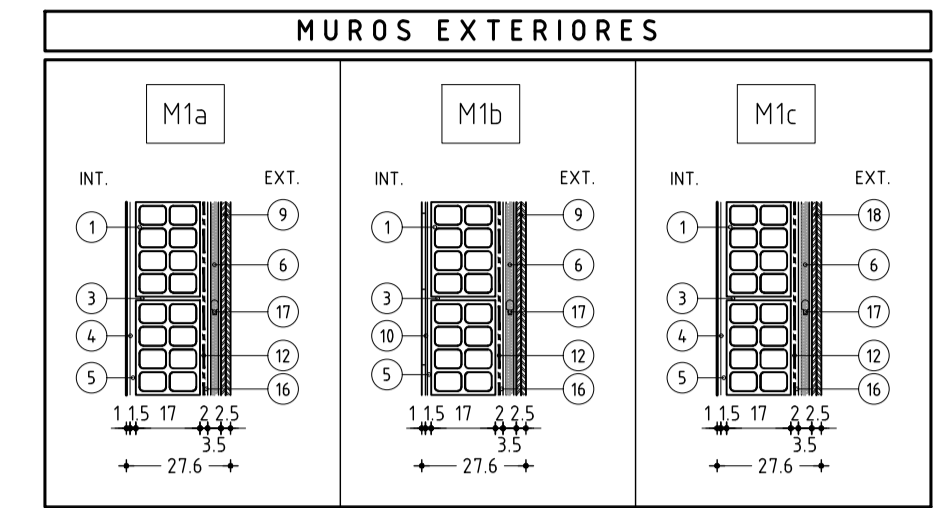

TERMINACIONES

PISOS	PAREDES
CIELORRASO	ZOCALOS

- PISOS**
- 1 - BALDOSA MONOLITICA S/MCP
  - 2 - HORMIGON S/MCP
- ZOCALOS**
- 1 - ZOCALO MONOLITICO S/MCP
  - 2 - MADERA S/MCP
- PARED**
- 1 - PINTURA S/MCP
  - 2 - REVOQUE Y PINTURA S/MCP
  - 3 - REVESTIMIENTO CERÁMICO S/MCP
- CIELORRASO**
- 1 - HORMIGON PINTADO S/MCP
  - 2 - DESMONTABLE S/MCP
  - 3 - PVC EN TABILLAS

<b>ANEP</b> AREA DE PROYECTOS		DIRECCIÓN SECTORIAL DE INFRAESTRUCTURA	
CORREJO DIRECTIVO CENTRAL			
OBRA: <b>LICEO N°4</b>	LOCALIDAD: <b>ARTIFAS</b>	FECHA: <b>8/2025</b>	
CALLE: <b>BLANDEGUES esq 18 DE MAYO</b>	DEPARTAMENTO: <b>ARTIFAS</b>	ESCALA: <b>INDICADAS</b>	
PLANO DE: <b>ALBANILERIA</b>	LÁMINA N°: <b>L16</b>		
DETALLES BAÑOS DOC./TISANERIA/S. LAC. LOCALES N°05 a 08			
ARQUITECTO:	FORMA:		
AYTE. de ARQUITO:	F. FEBRERO		
TECNICO:	FORMA:		
DIBUJANTE:			